



Bandwidth Requirements for Digital Voice

Bryan Hoyer - K7UDR

RF vs Network Protocols

- RF Protocols are designed to minimize BW while maintaining Data Integrity in a Noisy Environment.
- Network Protocols are designed to maximize thru-put in a generally reliable link.

Digital Voice RF BW

Protocol	Vocoder	Voice Data	FEC	Frame AuxData	TOTAL
Open	CODEC-2	Variable			700 +
D-STAR	AMBE	2400	1200	1200	4800
DMR	AMBE + 2	2450	1150	1200	4800
Fusion	AMBE + 2 HR	2450	1150	1200	4800
Fusion	AMBE + 2 FR	4900	2300	2400	9600

Ethernet II Frame

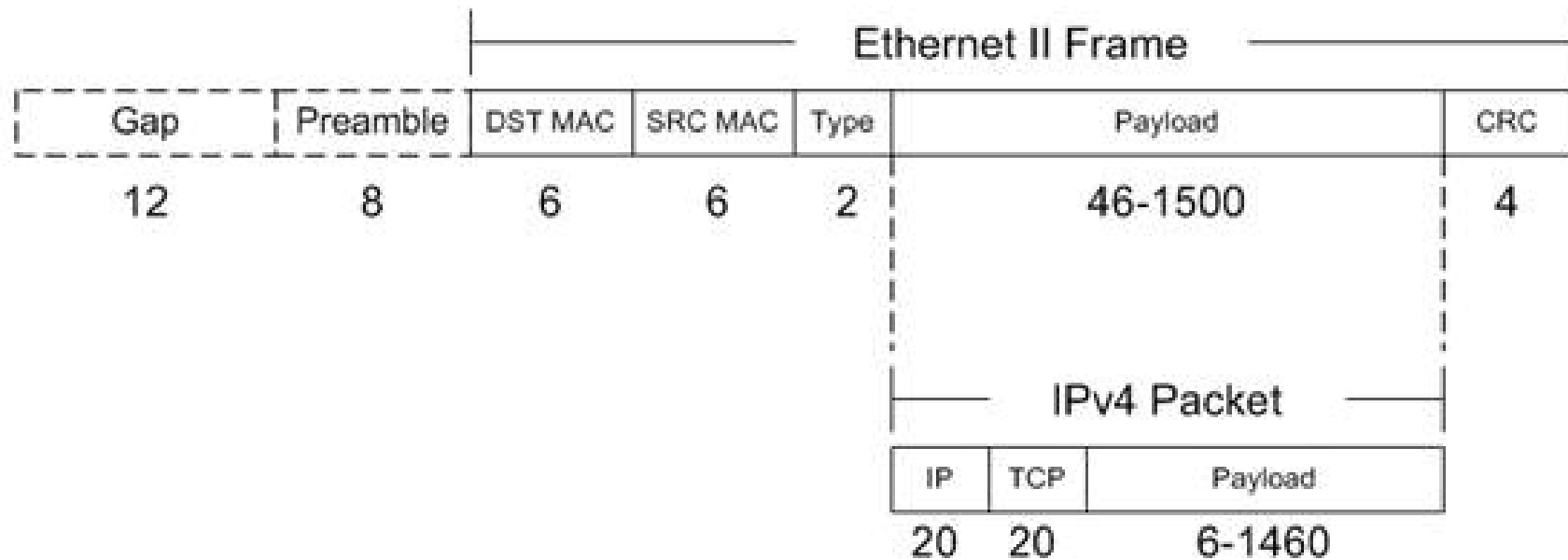

Data Requirements

	S/P	Pre	Header	DATA	CSUM	Gap	TOTAL	Rate
UDP	1	8	46	14	4	12	84	33600
TCP	1	8	58	9	4	12	91	36400
	2	8	58	18	4	12	100	20000
	3	8	58	27	4	12	109	14533
	4	8	58	36	4	12	118	11800
	5	8	58	45	4	12	127	10160
	6	8	58	54	4	12	136	9067
	7	8	58	63	4	12	145	8286
	8	8	58	72	4	12	154	7700

Things to Consider

- Multiple ways to do the same thing
 - D-Plus
 - X Reflector
 - DCS CCS
- DMR
 - Motorola Hytera ???

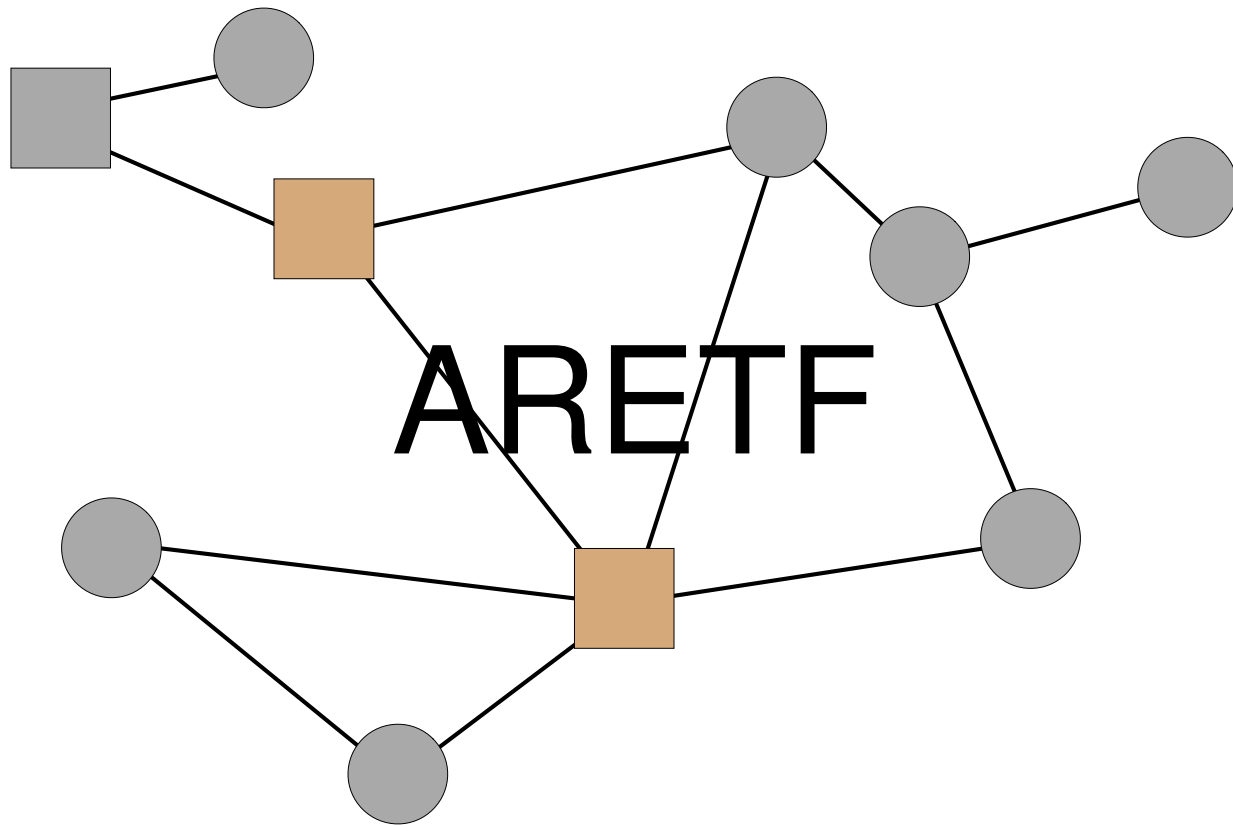

Internet Engineering Task Force

- Not a Club or Entity
- No Dues or Membership
- No Corporate Sponsorship
- Has no Authority
- Organized by Working Groups
- Operates on Rough Consensus

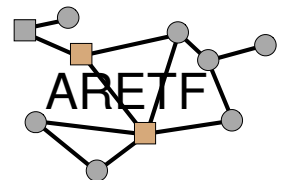

Goal of the ARETF

- Become The Place to further the Development, Testing and Dissemination of Amateur Radio Standards

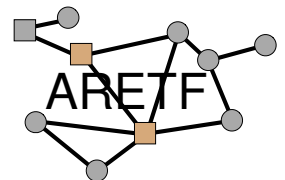

Status

- Forum is up
- Repository Established
 - Format defined
- Authentication WG
 - First Draft Published
- Digital Radio Testing WG

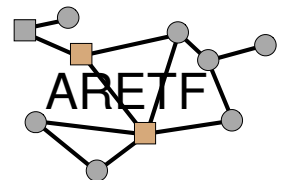

Interested?

www.ARETF.org

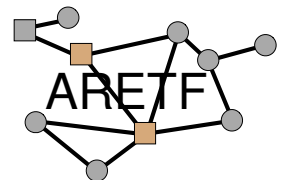

UDRX-440

Universal Digital Radio

- 25W 70cm SDR
- 4800 to over 100kbps
- AX25 and D-STAR
- Open Source Linux Server
- Network Interface via Web Browser
- 4 USB Accessory Ports



History

- Announced in 2012
- Total RF Re-Design in 2013
- Processor Board running continuously
- Prototype 3 working in RF Lab Now

Switching to the R-Pi 2

- Lower cost
- Current Design
- Ability to Upgrade in the Future
- Developer Community

UDRX Current SBC & RF Deck

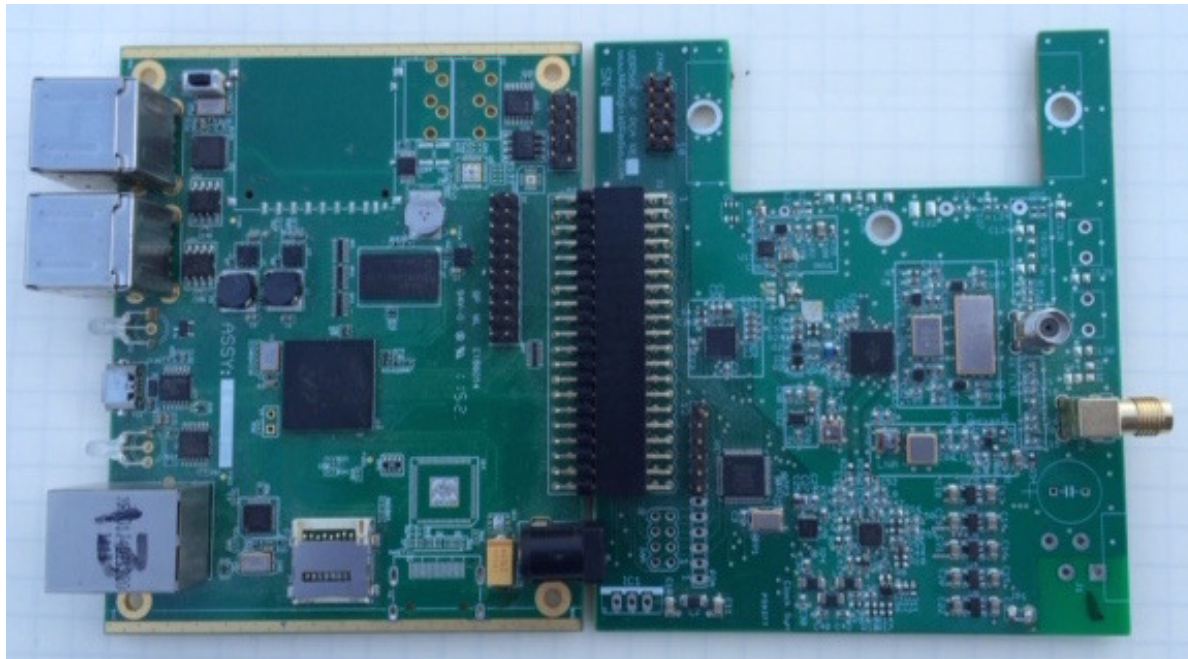

UDR SBC vs Raspberry Pi2

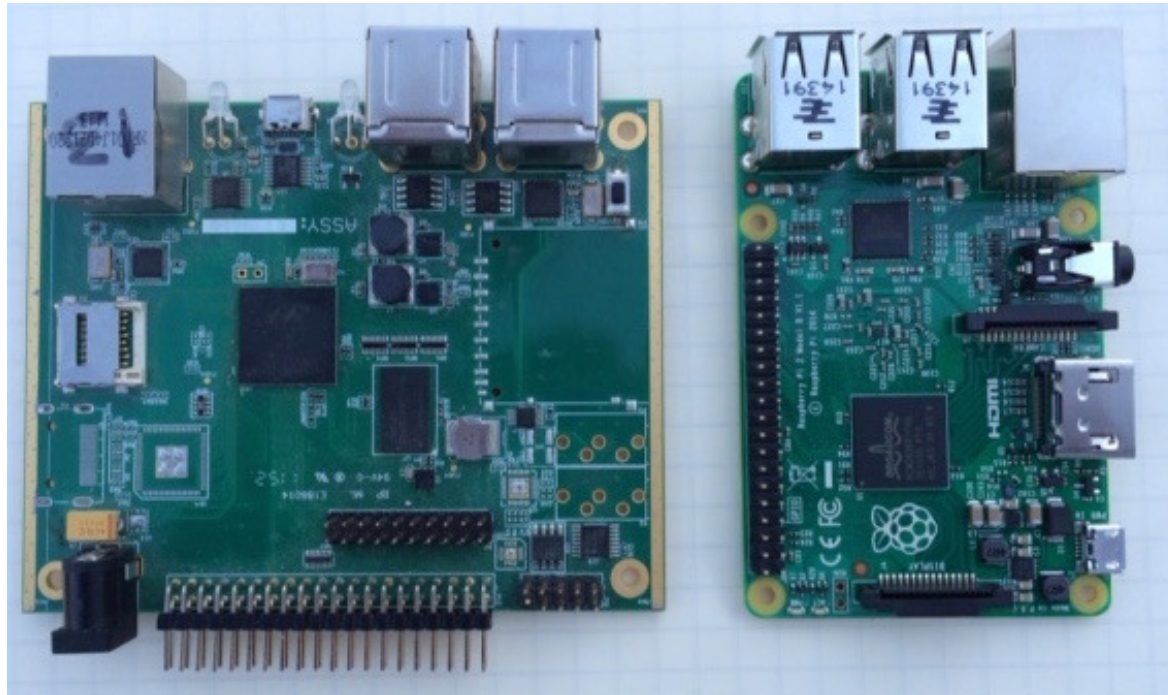

Cross-Connect Board

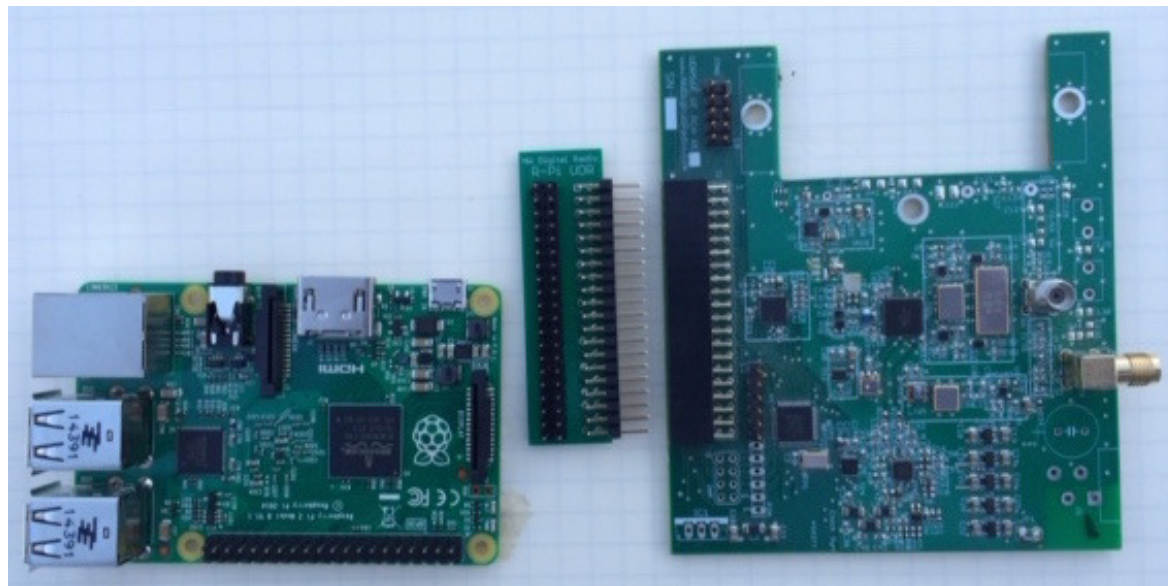

Test Configuration

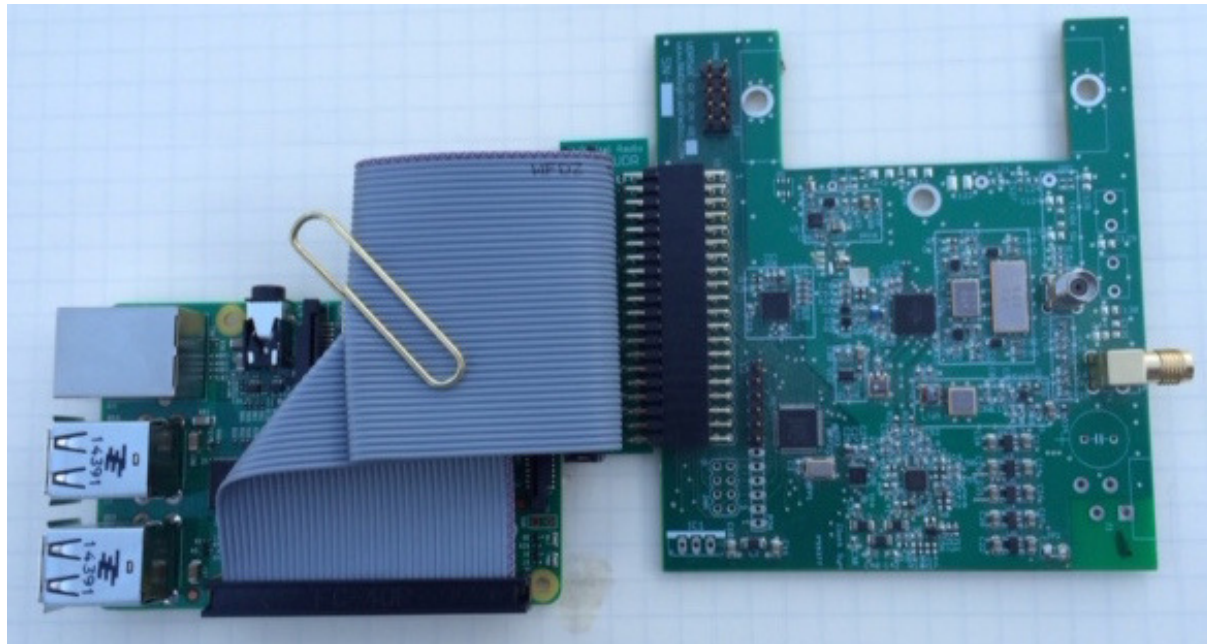

PiDV TM

- AMBE3000 Vocoder
- 26 Pin Raspberry Pi Header
 - Works with all R-Pi variants
- Serial Port Interface
- Standalone or AMBE Server

ThumbDV TM

- AMBE3000 Vocoder
- FTDI USB Serial Converter
- Standalone or AMBE Server

UDRC - Universal Digital Radio Controller

- Controller for Yaesu DRX-1
- Raspberry Pi 2 Shield
- Adds D-STAR 9600 Packet Support
 - Controller
 - Audio CODEC
 - 12V Powered