

CAT

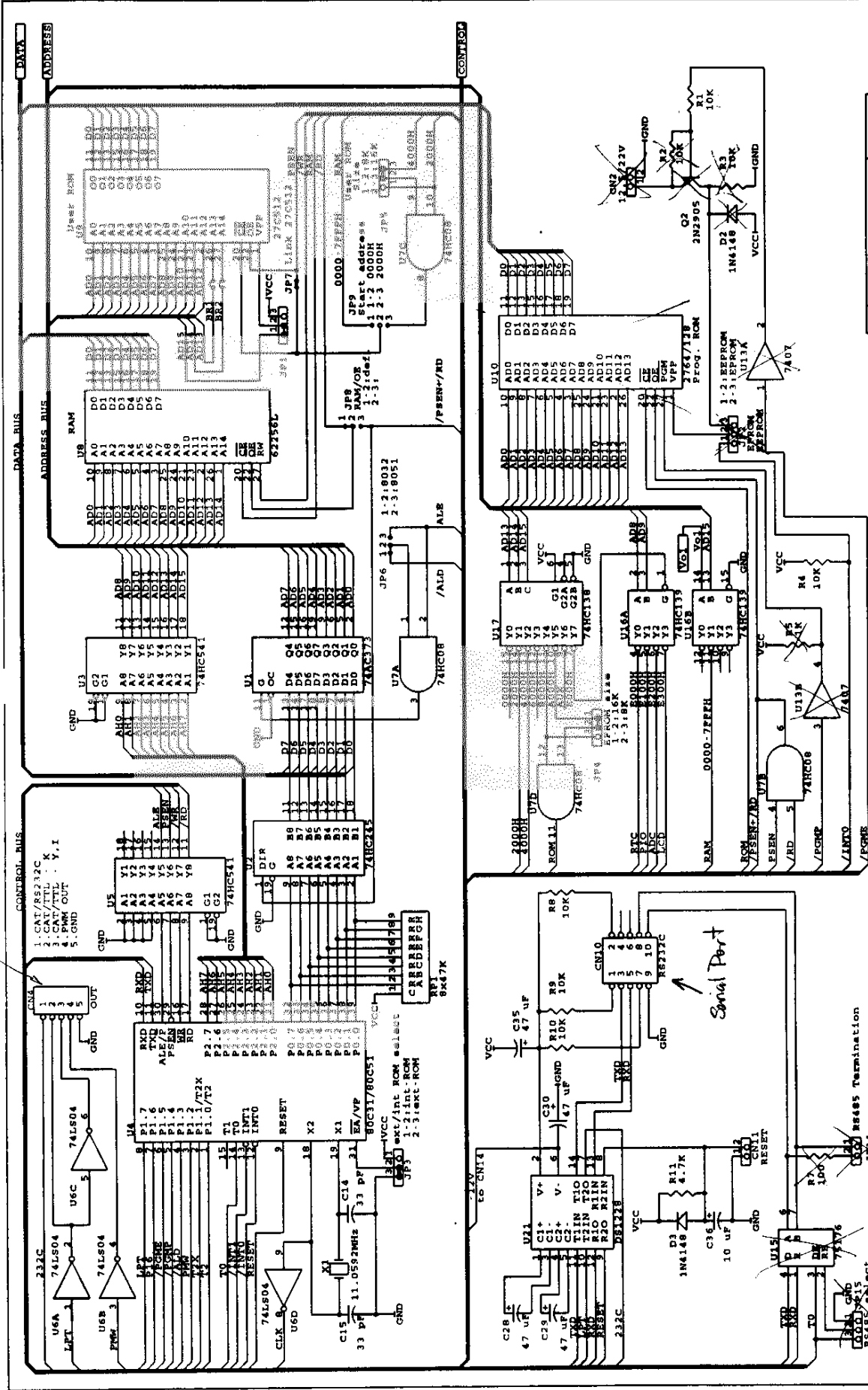

Unused parts note 930720

Title Trakbox - CPU, Memory, Serial I/O
 Size Document Number 930701
 Part 1 AUGUST 27, 1991 Rev B

NOTE
 The following components are not needed or used in the Trakbox configuration of this board and are not supplied with the TAPR kit:
 C15, U3, U6, U7, U8, U9, U10, U11, U12, U13, U14, U15, U16, U17, U18, U19, U20, U21, U22, U23, U24, U25, U26, U27, U28, U29, U30, U31, U32, U33, U34, U35, U36, U37, U38, U39, U40, U41, U42, U43, U44, U45, U46, U47, U48, U49, U50, U51, U52, U53, U54, U55, U56, U57, U58, U59, U60.

Serial Port

RS485 Termination

SEE NOTE

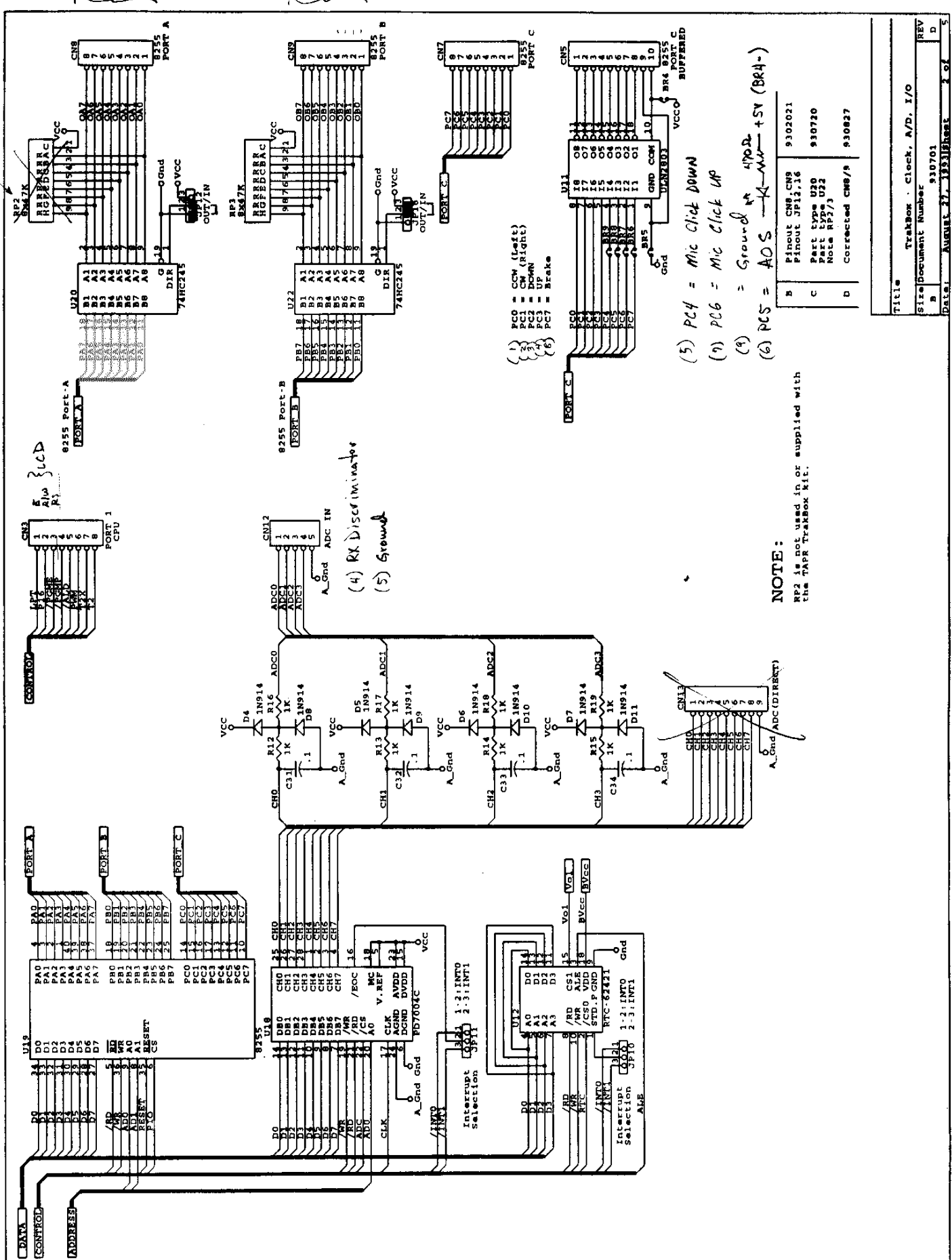

NOTE:

RP2 is not used in or supplied with the TAPR Trakbox kit.

- (5) PC4 = Mic Click DOWN
- (9) PC6 = Mic Click UP
- (9) PC5 = Ground
- (6) PC5 = AOS

- (1) PC0 = CCM (Left)
- (2) PC1 = CM (Right)
- (3) PC2 = DOWN
- (4) PC3 = UP
- (5) PC4 = Brake
- (6)

Pinout CN8-CN9	9302021
Pinout JP12,16	930720
Part Type U20	
Note RB2/3	
Corrected CN8/9	930827

Title	Trakbox - Clock, A/D, I/O
Size/Document Number	930701
Date	AUGUST 27, 1983/Sheet 2 of 5

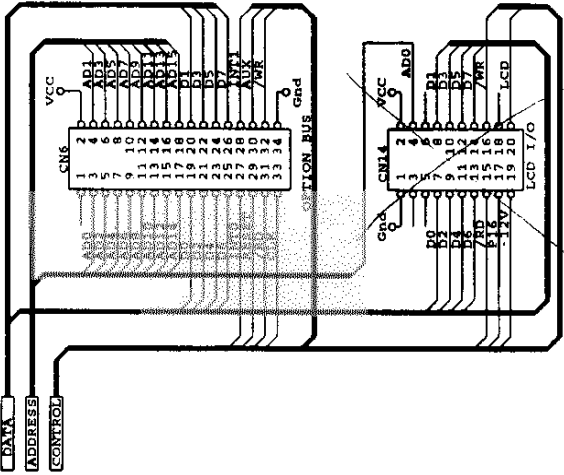

This LCD connection is not used with TrakBox V2.00

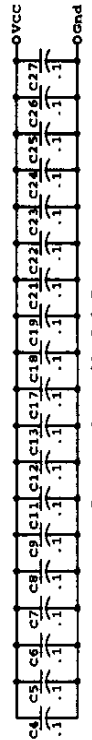
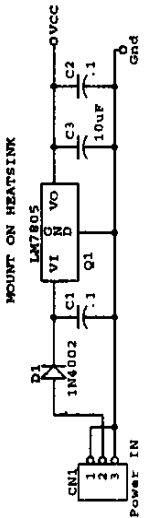
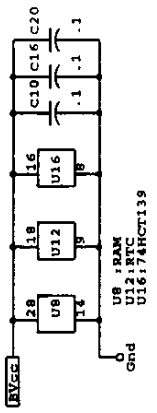
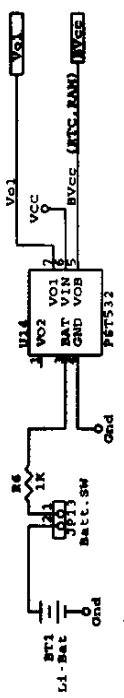

By-pass Caps all 0.1uF

U1	U2	U3	U4	U5	U6	U7	U8	U9	U10	U11	U12	U13	U14	U15	U16	U17	U18	U19	U20	U21	U22
20	20	20	20	40	20	14	14	28	10	18	14	6	8	16	15	26	20	16	20	16	20
GND	10	10	10	20	10	7	14	14	9	7	4	5	8	6	7	10	15	10			

*18Vcc BACKUP 3V

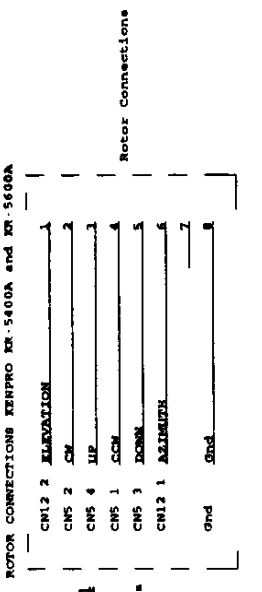

OPEN BR4

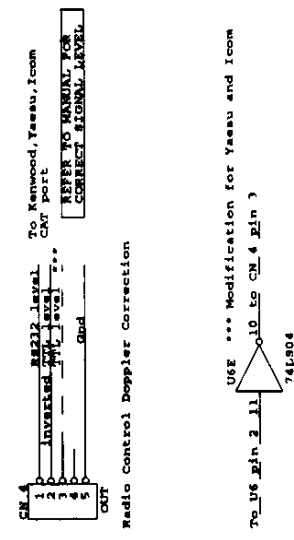
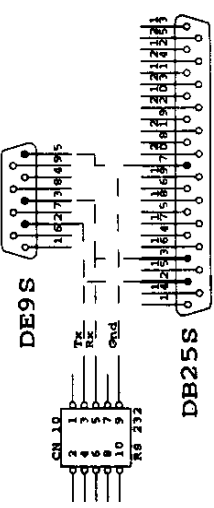
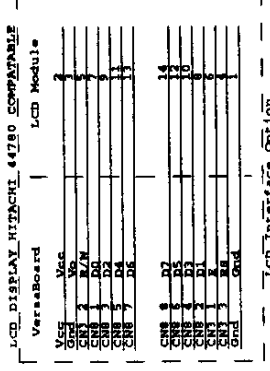

Radio Control Doppler Correction

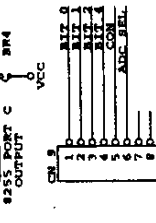
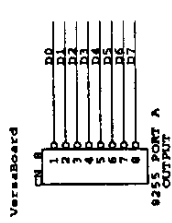
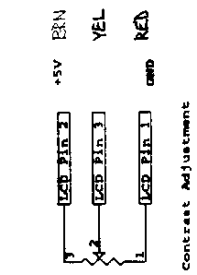
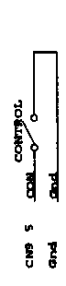
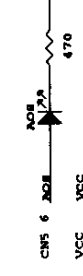
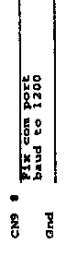

Title		Trakbox V9.30 Connections	
Size		Document Number: 941121	
REV		G	
DATE		November 20, 1994 Sheet 6 of 5	

NOTE: Use the TRIAC INTERFACE or the RELAY INTERFACE, but not both.

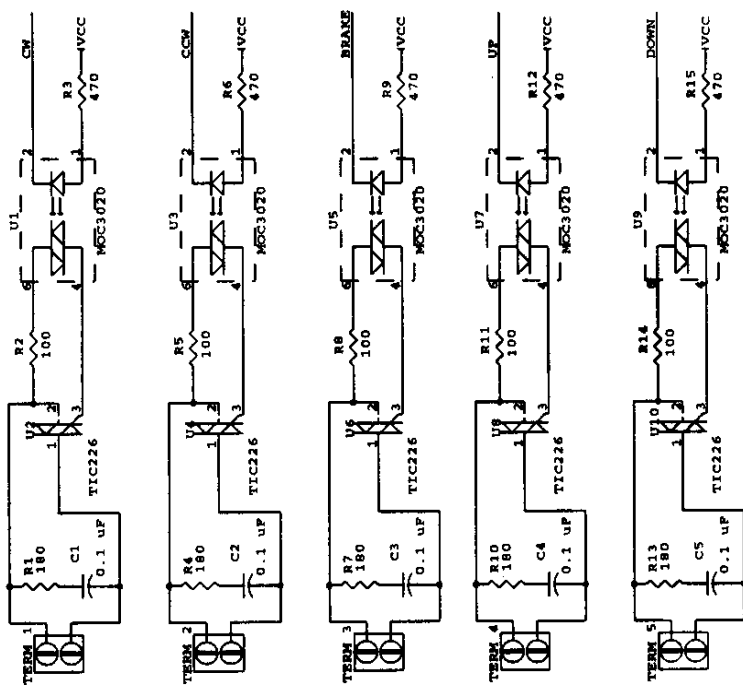

Triac Interface

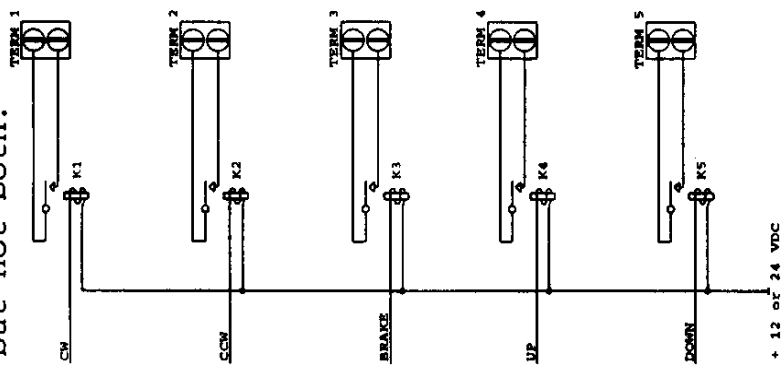

Relay Interface

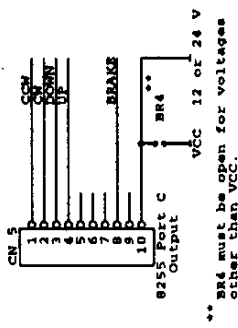

** BR4 must be open for voltages other than VCC.

Title	TrekBox Rotator Interfaces
Size/Document Number	930701
REV	A
DATE	AUGUST 27, 1993/EH/ast
	5 of 5